

PARTI DI RICAMBIO

SPARE PARTS

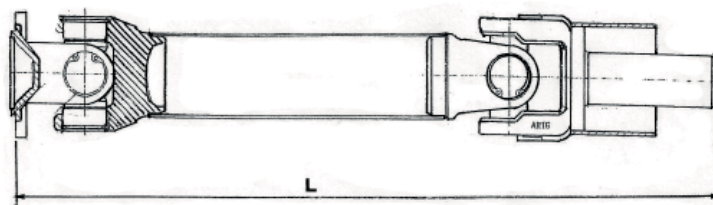

TRASMISSIONI CPL. SERIE AC 618 ADATTABILI A PIAGGIO PORTER DRIVE SHAFTS CPL SERIES ADAPTABLE TO PIAGGIO PORTER



DATI TECNICI / TECHNICAL DATA

O.E. N°	APPLICAZIONE	LUNGHEZZE (L)
B080003000003	4 X 4 POSTERIORE	325 mm
614365		383 mm
614636		370 mm
615338	VAN 16 VALVOLE	497,5 mm
615339	CASSONE 16 VALVOLE	515,5 mm
615340	FURGONE DIESEL	625,5 mm
615341	CASSONE DIESEL	640,5 mm
615342	VAN 1000 BENZINA	670 mm
588241		839,5 mm
BAG11-0005223	4 x 4 ANTERIORE	920 mm
B0800-1000001		975 mm

RIF.	DESCRIZIONE
AC618.001	GIUNTO SCORREVOLE AC 618 CPL
AC618.002	GIUNTO FISSO AC 618 CPL.
B 618	CROCERA
AC 618.003	FLANGIA AC 618 SAE 50
AC 618.004	FORCELLA FISSA AC 618
AC 618.005	MANICOTTO AC 618
TUB.051	TUBO DIAM. 51

I codici originali e le applicazioni sono riportati solo a titolo indicativo per favorire l'individuazione dei nostri prodotti

The original codes and applications are given only as a guideline to facilitate the identification of our products

TRASMISSIONI CPL. SERIE AC 620 ADATTABILI A GASOLONE TSH 35
DRIVE SHAFTS CPL SERIES ADATABLE TO GASOLONE THS 35
****O.E. N° H0000038700 (ex6060022000)**

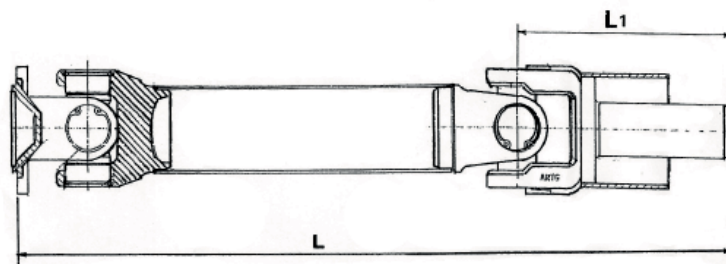

DATI TECNICI / TECHNICAL DATA

DESCRIZIONE	RIF. ARIG
TRASMISSIONE CPL. L=480 +/-1	AC 620
Crocera 27 x 80	B 80
Flangia SAE - diametro centraggio 45	
crf fori= 79,2 / 4 fori diam. 10,5	FL.620.001
Forcella fissa per tubo diam. 74,5 x 2,25	FT.082.022
Tubo diam. 74,5 x 2,25	TUB074
Manicotto brocciato 25 denti L1=135,5 diam. Esterno 39,40	MB.620.001

I codici originali e le applicazioni sono riportati solo a titolo indicativo per favorire l'individuazione dei nostri prodotti

The original codes and applications are given only as a guideline to facilitate the identification of our products

TRASMISSIONI ADATTABILI AD IVECO DAILY CARDAN TRASMISSION ADAPTABLE TO IVECO DAILY

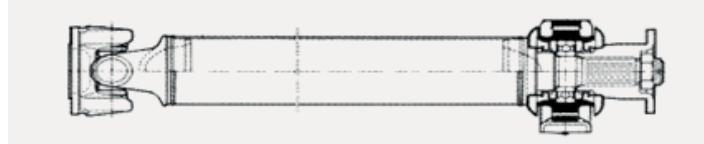
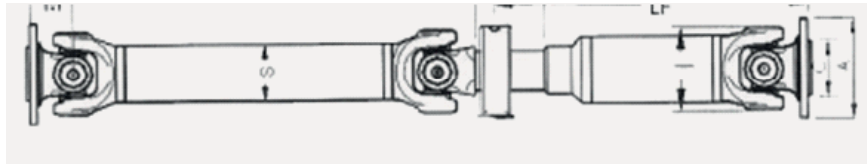

Descrizione	RIG. ARIG
Crocera cpl. 27 x 81,7	B 82
Crocera cpl 30,2 x 82	B 767
Crocera cpl 30,2 x 106,3	B 106
Flange AC 82 (27 X 81,7) SAE 1300 (SAE 60,32 /4 fori diam.10,25)	FL.082.003
Flange AC 82 (27 X 81,7) SAE 1400 (SAE 69 /4 fori diam. 12,25)	FL. 082.005
Flange AC767(30,2 X 82) SAE 1400 (SAE 69 / 4 fori diam. 12,25)	FL.767.002
Flange AC 106 SAE 1400 (SAE 69 / 4 fori diam. 12,25)	FL.106.001
Forcelle fisse AC767 diam. 76,2 x 2,4	FL.687.211
Forcelle fisse AC 106 diam. 76,2 x 2,4	FL.106.019
Forcelle fisse AC 106 diam. 74,5 x 2,25	FL.106.020
Gruppo Mis cpl. Di supporto diam. 40 int. 168 tubo 76,2 x 2,4 (per crocera 27 x 81,7) (Kit completo di : N.1 Crocera+n. 1 forcella + mis con supporto)	GM082.001
Gruppo Mis cpl. Di supporto diam. 40 int. 168 tubo 76,2 x 2,4 (30,2 x 106,3) (Kit completo di : N. 1 Crocera + n. 1 forcella + mis con supporto)	GM106.001
Gruppo supporto cpl. Diam. 40 SAE 1400 tubo 76,2 x 2,4	GS.106.001
Gruppo supporto cpl. Diam. 35 SAE 1400 - tubo 76,2 x 2,4	GS.082.001
Tubo diam. 76,2 x 2,4	
Tubo diam. 74,5 x 2,25	
Supporto diam. 35	S 35.001
Supporto diam. 40	S 40.001/5
Supporto diam. 40	S 40.004
Supporto diam. 40	S 40.007
Supporto diam. 45	S 45.001/3
Supporto diam. 45	S 45.015

I codici originali e le applicazioni sono riportati solo a titolo indicativo per favorire l'individuazione dei nostri prodotti

The original codes and applications are given only as a guideline to facilitate the identification of our products

**TRASMISSIONI ADATTABILI A NISSAN VANETTE SERENA
CARDAN TRANSMISSION ADAPTABLE TO NISSAN VANETTE SERENA**

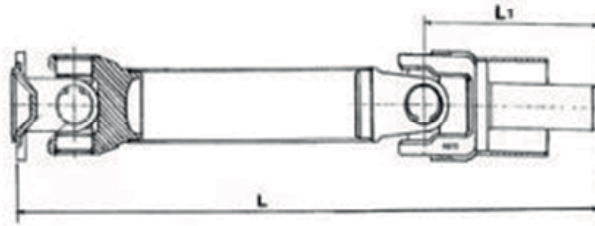

DESCRIZIONE	RIF.ARIG
TRASMISSIONE CPL. L= 673,5 tubo diam.74	NS.673
TRASMISSIONE CPL. L= 769 tubo diam.51	NS.769
TRASMISSIONE CPL. L= 833 tubo diam. 51	NS.833
TRASMISSIONE CPL. L= 928 tubo diam. 51	NS.928
(flange montate SAE - C= 50 cfr fori 81/ 4 fori diam. 10,25	

I codici originali e le applicazioni sono riportati solo a titolo indicativo per favorire l'individuazione dei nostri prodotti

The original codes and applications are given only as a guideline to facilitate the identification of our products

TRASMISSIONI SERIE AC 75 ADATTABILI A FORD TRANSIT SHAFTS SERIES AC75 ADAPTABLE TO FORD TRANSIT

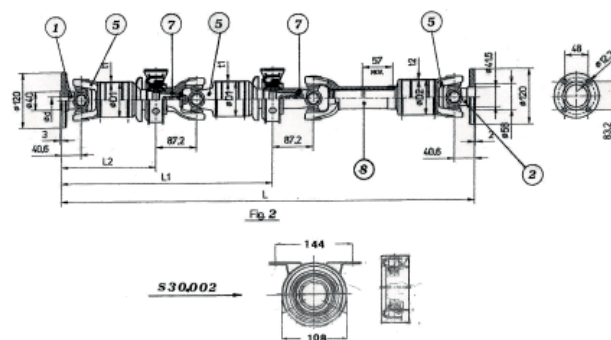
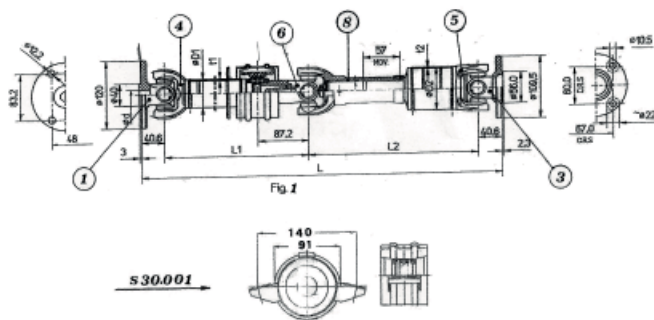

DATI TECNICI / TECHNICAL DATA

DESCRIZIONE	RIF. COD ARIG
Trasmissione cpl. Con 1 supporto - L = 2480 mm non saldata lato forcelle fisse al tubo FLANGE : Lato supporto SAE - C = 40 mm Lato scorrevole SAE - C = 56 mm	TR 130.001
Trasmissione cpl. Con 2 supporto - L = 2800 mm non saldata lato forcelle fisse al tubo FLANGE : Lato supporto SAE - C = 40 mm Lato scorrevole SAE - C = 56 mm	TR 130.002

	DESCRIZIONE	RIF.	COD ARIG
AC 75 (Ford Transit crocere 27 x 74,6 con anelli seeger)	Crocera cpl. - 27 x 74,6		B 75
	Crocera cpl. - 30,2 x 81,8		B 30
	Flangia SAE - diam. Esterno 120 mm Centraggio = 40 mm - Foro diam. 17 mm	1	FL 075.001
	Flangia SAE - diam. Esterno 120 mm Centraggio = 56 mm - Foro diam. 36 mm	2	FL 075.011
	Flangia SAE - diam. Esterno 109mm Centraggio = 56 mm	3	FL 075.010
	Scorrevole cpl. - Nylon Corsa + 50 - tubo 76,2 x 1,6	8	SC 075.300
	Forcella fissa - tubo 50,8 x 2,4	4	FT 075.020
	Forcella fissa - tubo 76,2 x 1,6	5	FT 075.021
	Perno con forcella per semitrasmissione cpl. Di rondella e vite - tubo 50,8 x 32,4	6	PS 075.030
	Perno con forcella per semitrasmissione cpl. Di rondella e vite - tubo 76,2 x 1,6	7	PS 075.031

I codici originali e le applicazioni sono riportati solo a titolo indicativo per favorire l'individuazione dei nostri prodotti

The original codes and applications are given only as a guideline to facilitate the identification of our products

CROCERE UNIVERSAL JOINTS

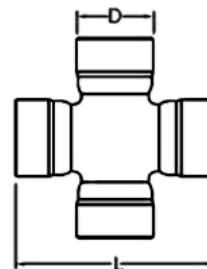

D X L	RIF. ARIG PART N°	APPLICAZIONE / APPLICATION	RIF. ORIGINALE ORIGINAL N°
23,8 x 61,3	B 62	Fiat / Alfa Romeo	883235 - 4548769 - 4605734 - 9961775
27 x 74,6	B 75	Fiat / Landa Rover / Renault / Transit	348472 - 967265 - 943541019
27 x 74,8	B 768	Iveco	
27 x 81,75	B 82	Iveco / Daily / Range Rover / Jeep	9984268 - 9984381 - 93163407 - 93160322
30,2 x 81,8	B 30	Iveco	42530886
30,2 x 92	B 92	Fiat / International	8197741 - 9959679
30,2 x 106,3	B 106	Iveco / Daily / Daf / Renault	4655182 - 92601339 - 93158199 -
		Same / Komatsu	943541418 - 4675624 - 38464 - 608921
32 x 106,3	B 107		
34,9 x 106,4	B 35	Iveco / Eurocargo	93160225
35 x 96,8	B 96	Fiat	9927092
35 x 106,4	B 36	Iveco / Eurocargo	
39,7 x 115,95	B 116	Iveco / Daf / Volvo / Scania	4679190 - 5985281 - 7605143 - 7984508
			316340 - 943541500 - 750610 - 6852612
42 x 119,4	B 119	Eurocargo	42533841 - 93160228
47,6 x 135,2	B 47	Iveco / Eurocargo	93160516
48 x 116,5	B 148	Iveco / Man / Daf	2980490 - 42484713 - 93159313 - 81392006011
48 x 126	B 126	Iveco / Mercedes / Renault	3874100131
48 x 135,2	B 48	Iveco / Eurocargo	93192015
48 x 161	B 161	Scania	294383 - 365913
50 x 152,6	B 153	Daf / Man / Volvo	232459 - 1651032
52 x 133	B 133	Iveco / Daf / Man / Mercedes /	93159316 - 103261 - 8198583 - 264354
		Renault	81392006016 - 3354100031 - 93159300
52 x 147,2	B 52	Iveco / Eurotech	42533410 - 93163090
53 x 135	B 135	Mercedes	3634100631
57 x 144	B 144	Daf / Iveco / Man / Mercedes /	2980217 - 42491973 - 42980217 - 505698
		Renault / Volvo	93190028 - 81392006015 - 232540
57 x 152	B 57	Iveco / Astra / Mercedes / Renault	103269 - 3874100031 - 93157114
57 x 164	B 164	Scania	294385
57 x 172	B 68	Eurotrakker	93157114 - 93160297
65 x 172	B 172	Iveco	8194583 - 42490052 - 93156581 - 93159498
68,04x89x166	B 89	Mercedes 1948	6564100131
18 x 47	B 18	Settore Agricolo - Ingrassatore centrale - Agricultural / centre grease	
19 x 51,9	B 19	Settore Agricolo - Ingrassatore centrale - Agricultural / centre grease	
22 x 54,8	B 54	Settore Agricolo - Ingrassatore centrale - Agricultural / centre grease	
27 x 70	B 70	Settore Agricolo - Ingrassatore centrale - Agricultural / centre grease	
27 x 74,5	B 15	Settore Agricolo - Ingrassatore centrale - Agricultural / centre grease	
41 x 118	B 118	Settore Agricolo - Ingrassatore centrale - Agricultural / centre grease	

I codici originali e le applicazioni sono riportati solo a titolo indicativo per favorire l'individuazione dei nostri prodotti

The original codes and applications are given only as a guideline to facilitate the identification of our products

CROCERE UNIVERSAL JOINTS

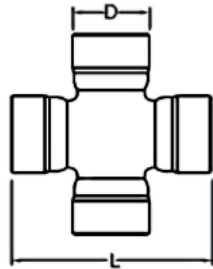

1

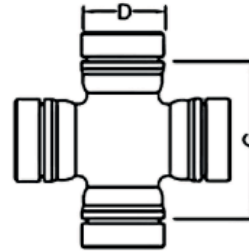

2

D x L	FIGURA PICTURE	RIF. ARIG PART N°	APPLICAZIONE APPLICATION	NOTE	Rif. Originale Original N°
27,00 x 61,85	1	B 618	Piaggio Porter	Ingrassatore su testa - grease on the cup	
26,00 x 53,35	2	B 535	Toyota	Ingrassatore laterale - side grease	04371 30011
29,00 x 49,00	2	B 490	Toyota	Ingrassatore centrale - centre grease	04371 - 30020
27,00 x 45,90	2	B 459	Nissan	Long Life	
25,00 x 40,00	2	B 400	Nissan	Ingrassatore su testa - grease on the cup	37125 - 14627
28,00 x 53,00	2	B 530	Nissan	Ingrassatore laterale - side grease	37125 - 21025
25,01 x 52,00	2	B 520	Nissan	Ingrassatore centrale - centre grease	37125 - 76025
26,00 x 45,60	2	B 456	Nissan	Ingrassatore laterale - side grease	37125 - 68200
25,00 x 63,80	1	B 638	Daihatsu + varie	Ingrassatore su testa - grease on the cup	4123 - 4120
20,01 x 35,00	2	B 350	Suzuki - Nissan	Ingrassatore su testa - grease on the cup	27100 - 67000
29,00 x 50,00	2	B 500	Isuzu	Ingrassatore laterale - side grease	9-37300 - 065
30,00 x 55,10	2	B 551	Mitsubishi	Ingrassatore centrale - centre grease	MB 000267
22,50 x 35,00	2	B 351	Mazda	Ingrassatore su testa - grease on the cup	3919 - 39 - 251
26,50 x 48,00	2	B 480	Mazda	Ingrassatore su testa - grease on the cup	1557 - 89 - 251
25,00 x 41,20	2	B 412	Mazda	Ingrassatore su testa - grease on the cup	0259 - 25 - 060
28,00 x 56,00	2	B 560	Mazda	Ingrassatore su testa - grease on the cup	0706 - 89 - 251
32,00 x 57,00	2	B 570	Mazda	Ingrassatore centrale - centre grease	0164 - 25 - 060
36,00 x 97,00	1	B 597	Isuzu	Ingrassatore laterale - side grease	9 - 37300 - 055
28,57 x 49	2	B 285	Toyota	Ingrassatore su testa - grease on the cup	
25 x 76,50	1	B 765	Mitsubishi	Ingrassatore su testa - grease on the cup	MB 000776
24 x 63,30	1	B 633	Alfa Romeo	Long Life	60711616
27 x 80	1	B 80	Hyunday	Ingrassatore laterale - side grease	49140 - 4A00

I codici originali e le applicazioni sono riportati solo a titolo indicativo per favorire l'individuazione dei nostri prodotti

The original codes and applications are given only as a guideline to facilitate the identification of our products

CROCERE MECHANICS UNIVERSAL JOINTS MECHANICS

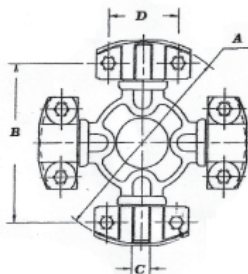
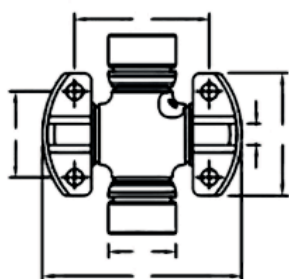

Blocchetti alti
Fori passanti



Blocchetti alti
Fori filettati



Blocchetti bassi
Fori passanti



Blocchetti bassi
Fori filettati

TIPO/TYPE	A MM	B MM	D MM	C MM	TIPO DI ATTACCO / ATTACK TYPE	RIF. ARIG
4 C	108	87.3	36.52	9.5	4 Blocchetti alti - fori passanti 4 High wing drilled	400.001
5 C	115	88.9	42.9	14.26	2 Blocchetti alti - fori passanti 2 Blocchetti bassi - fori filettati 2 High wing drilled 2 Low wing threaded	500.001
5 C	115	88.9	42.9	14.26	4 Blocchetti bassi - fori filettati 4 low wing threaded	500.002
5 C	115	88.9	42.9	14.26	4 Blocchetti alti - fori passanti 4 High wing drilled	500.003
6 C	140.46	114.3	42.9	14.26	2 Blocchetti alti - fori passanti 2 Blocchetti bassi - fori filettati 2 High wing drilled 2 Low wing threaded	600.001
6 C	140.46	114.3	42.9	14.26	4 Blocchetti alti - fori passanti 4 High wing drilled	600.002
7 C	148.4	117.5	49.2	15.85	4 Blocchetti alti - fori passanti 4 High wing drilled	700.001
7 C	148.4	117.5	49.2	15.85	2 Blocchetti alti - fori passanti 2 Blocchetti bassi - fori filettati 2 High wing drilled 2 Low wing threaded	700.002
8 C	206.32	174.6	49.2	15.85	4 Blocchetti alti - fori passanti 4 High wing drilled	800.001
8,5 C	165	123.8	71.44	15.85	4 Blocchetti bassi - fori passanti 4 Low wing drilled	850.001
8,5 C	165	123.8	71.44	15.85	4 Blocchetti alti - fori passanti 4 High wing drilled	850.002
8,5 C	165	123.8	71.44	15.85	2 Blocchetti alti - fori passanti 2 Blocchetti alti - fori filettati 2 High wing drilled 2 Delte wing threaded	850.003
9 C	209.52	168.28	71.44	15.85	4 Blocchetti alti - fori passanti 4 High wing drilled	900.001

I codici originali e le applicazioni sono riportati solo a titolo indicativo per favorire l'individuazione dei nostri prodotti

The original codes and applications are given only as a guideline to facilitate the identification of our products

COMPONENTI PER TRASMISSIONI SPARE PARTS

TIPO	DESCRIZIONE	RIF. ARIG
AC 62	Crocera cpl. - 23,8 x 61,3 ingr. Su boccola	B 62
	Scorrevole cpl. - corsa + 50 - tubo 44,5 x 1,7 - Nylon L=147mm	SC 062.100
	Scorrevole cpl. - corsa + 50 - tubo 51 x 2,5 - Nylon - L=150mm	SC 062.200
	Forcella fissa per tubo 44,5 x 1,7 H=41	FT 062.020
	Forcella fissa per tubo diam. 51 x 2,5 - H=39	FT 062.021
	Flangia SAE 57 - 4 fori / 8,25 - H = 33	FL 062.001
	Flangia DIN 75 - 6 fori / 6 - H = 42	FL 062.010
	Flangia DIN 90 - 4 fori / 8,5 - H = 33	FL 062.011
	Flangia DIN 90 senza fori	FL.062.012
AC 768	Crocera cpl. - 27 x 74,8 - "Compatta"	B 768
	Scorrevole cpl. - corsa + 40 - tubo 51 x 2,5 - Nylon	SC 768.100
	Scorrevole cpl. - corsa + 60 - tubo 63,5 x 2,4 - Nylon	SC768.200
	Scorrevole cpl. Corsa +100 - tubo 50,8 x 2,41	SC768.300
	Forcella fissa per tubo 51 x 2,5	FT 768.020
	Forcella fissa 63,5 x 2,4	FT 768.021
	Flangia SAE 57 - 4 fori / 8,25 - H = 43	FL 768.001
	Flangia SAE 60 - 4 fori / 10,25 - H = 43	FL 768.002
	Flangia DIN100/6/8,5	FL.768.004
	Flangia DIN 100 non forata	FL.768.005
	Flangia DIN 90 - 4 fori / 8,5 - H = 50	FL 768.003
AC 82	Crocera cpl. - 27 x 81,7	B 82
	Scorrevole cpl - corsa + 50 - tubo 51 x 2,5 - Nylon	SC 082.100
	Scorrevole cpl. - corsa + 50 35° -tubo diam. 51 x 2,5 nylon	SC 082.200
	Scorrevole cpl - corsa + 50 - tubo 74,5 x 2,25 - Nylon	SC 082.300
	Scorrevole cpl - corsa + 50 - tubo 76,2 x 1,6 - Nylon	SC 082.500
	Forcella fissa - tubo 51 x 2,5	FT 082.020
	Forcella fissa - tubo 51 x 2,5 35°	FT082.021
	Forcella fissa - tubo 74,5 x 2,25	FT 082.022
	Forcella fissa - tubo 76 x 1,6	FT082.023
	Flangia SAE 57 - 4 fori /8,25 - H = 39,5	FL 082.001
	Flangia SAE 60 - 4 fori / 10,25 - H = 35 - bassa	FL 082.002
	Flangia SAE 60 - 4 fori / 10,25 - H = 43,5 - normale	FL 082.003
	Flangia SAE 60 - 4 fori / 10,25 - H = 58 - alta	FL 082.004
	Flangia SAE 69 / 4 fori / 12,25 - H = 50,5	FL.082.005
	Flangia DIN 90 - 4 fori / 8,5 - H = 40	FL 082.010
	Flangia DIN 100 - 6 fori / 8,5 - H = 59,5	FL 082.013
	Flangia DIN 120 - 8 fori /10,5 - H = 51	FL 082.016
	Flangia per Nissan Navara C=50 /4 fori/12	FL.082.017
	Flangia per Nissan Cabstar C=65 /4 fori 12	FL.082.018
	Controflange SAE 60,32	CF.082.001
	Gruppo supporto cpl. Diam.35 sae 1410 tubo 76,2	GS082.001
	Gruppo mis (composto da N.1 gruppo scorr.le con supporto- Diam.40 int.168 + n.1 crociera + n.1 forcella fissa diam. 76	GM082.001

I codici originali e le applicazioni sono riportati solo a titolo indicativo per favorire l'individuazione dei nostri prodotti

The original codes and applications are given only as a guideline to facilitate the identification of our products

COMPONENTI PER TRASMISSIONI SPARE PARTS

TIPO	DESCRIZIONE	RIF. ARIG
AC 92	Crocera cpl. - 30,2 x 92	B 92
	Scorrevole cpl.- corsa + 50 - tubo 74,5 x 2,25 - Nylon	SC 092.100
	Forcella fissa per tubo 74,5 x 2,25	FT 092.020
	Flangia SAE 69 - 4 fori / 12,25 - H = 43	FL 092.002
	Flangia SAE 69 senza fori	FL.092.011
	Flangia DIN 100 - 6 fori / 8,5 - H = 65	FL 092.010
AC 92 S	Forcella fissa - tubo 61 x 3	FT 092.021
	Scorrevole cpl + 110 (cmp.: forcella innesto+boccola TUBO 60	SC092,200
	Forcella fissa forata	FT 092.050
AC 767	Crocera cpl. - 30,2 x 81,8 -"Compatta"	B 767
	Scorrevole cpl.- corsa + 50 - tubo 60 x 2,5 - Nylon	SC 767.100
	Forcella fissa - tubo 60 x 2,5 35°	FT 767.020
2020	Forcella fissa - tubo 63,5 x 2,4	FT 767.022
	Flangia SAE 60 - 4 fori / 10,25 - H = 51	FL 767.001
	Flangia SAE 69 - 4 fori / 12,25 - H = 58	FL 767.002
	Flangia DIN 100 - 6 fori / 8,5 - H = 58	FL 767.003
	Flangia DIN 120 - 8 fori / 10,5 - H = 58	FL 767.004
	Flangia DIN 132 - 4 fori /10,25 - H=58 C=67 mercedes sprinter	FL.767.005
	Flangia adattabile a Nissan Cabstar diam. 121 C=65 4 fori da 12	FL.767.006
AC767 WS	Scorrevole cpl.- corsa + 110 - tubo 60 x 2,5 - 35° - Nylon	SC 767.300
AC 106	Crocera cpl. - 30,2 x 106,3	B 106
	Scorrevole cpl. - corsa + 57 - tubo 74,5 x 2,25	SC 106.100
	Scorrevole cpl. - corsa + 57 - tubo 76,2 x 2,4 - Nylon	SC 106.500
	Forcella fissa - tubo 74,5 x 2,25	FT 106.020
	Forcelle fisse - tubo 76 x 2,4	FT 106.019
	Flangia SAE 69 - 4 fori / 12,25 - H = 43	FL 106.001
	Flangia SAE 69 senza fori	FL.106.016
	FLANGIA DIN 100 - 6 fori / 8,5 - H = 51	FL 106.010
	FLANGIA DIN 100 - 8 fori / 8,5 - H = 67	FL 106.011
	FLANGIA DIN 100 senza fori	FL.106.017
	FLANGIA DIN 120 - 8 fori / 10,5 - H =56	FL 106.013
	FLANGIA DIN 120 - 8 fori / 10,5 - H = 69	FL 106.014
	FLANGIA SAE 4 fori /12C =75 - H=70 adattabili a nissan	FL.106.015
	Gruppo supporto cpl. Diam.40 per albero ant. Tubo 76,2 sae1410	GS.106.001
	Gruppo Mis 1410 cpl di supporto diam.40 int.168 sae 1410 Tubo 76 (n.1 forcella + n.1 crocera + n. 1 scorr.+1 supp)	GM.106.001
AC 116	Crocere cpl. - 39,7 x 115,95	B 116
	Scorrevole cpl. - corsa + 110 - tubo 90 x 4	SC 116.100
	Scorrevole cpl. - corsa + 80 - tubo 75 x 3 - Nylon	SC 116.200
	Forcella fissa - tubo 90 x 4	FT 116.020
	Forcella fissa - tubo 75 x 3	FT 116.021
	Flangia SAE 95 - 4 fori / 14,25 - H = 61 - normale	FL 116.002
	Flangia DIN 120 - 8 fori / 10,5 - H = 72	FL 116.010
	Flangia DIN 150 - 8 fori / 12,5 - H = 78,5	FL 116.012

COMPONENTI PER TRASMISSIONI SPARE PARTS

TUBO / TUBE

	DESCRIZIONE	RIF.ARIG
D x S	44,5 x 1,7 - per tipo : AC 62	TUB044
	51 x 2,5 - per tipo : AC 62 / AC 82 / AC 618 / AC 768	TUB051
	60 x 2,5 - per tipo: AC 92 ws / AC 767	TUB060
	60 x 3 - per AC 767	TUB060.03
	74,5 x 2,25 - per tipo: AC 82 / AC 92 / AC 106	TUB074
	75 x 3 - per tipo : AC 116	TUB075
	76,2 x 2,4 - per tipo : 687.20	TUB076
	89 x 2,4 - per tipo : AC 116 / 687.30	TUB089
	92 x 5 - per tipo : 385	TUB092
	110 x 6 - per tipo : 587.35 / 687.55	TUB110
	120 x 4 - per tipo : 687.40 / 687.45	TUB120
	120 x 6 - per tipo : 687.55	TUB120.06

SCORREVOLI cpl EXTRACORTI / SLIDING JOKE EXTRASHORT

TIPO	DESCRIZIONE	RIF. ARIG
AC62	SCORREVOLE cpl. KN 1 - L= 118 + 17	SC062.301
	SCORREVOLE cpl. KN 2 - L = 133 + 28	SC 062.302
	SCORREVOLE cpl. KN5 - L = 174 + 40	SC 062 305
AC82	SCORREVOLE cpl. KN1 - L=138 + 27	SC082.301
	SCORREVOLE cpl. KN3 - L = 170 + 35	SC 082,303
	SCORREVOLE cpl. KN4 - L = 185 + 40	SC 082.304
AC 767	SCORREVOLE cpl. Special KN - L = 112 + 22	SC767.299
	SCORREVOLE cpl. KN0 - L = 187 + 50	SC 767.300
	SCORREVOLE cpl. KN1 - L = 200 + 50	SC 767.301
	SCORREVOLE cpl. KN2 - L = 240 + 50	SC 767.302
AC106	SCORREVOLE cpl. F / C - L = 198+ 30	SC 106.300
	SCORREVOLE cpl. KN 1 - L = 206 + 35 - Nylon	SC 106.304
	SCORREVOLE cpl. KN 5 - L = 244 + 60	SC 106.305
AC 116	SCORREVOLE cpl. KN1 - L = 180 + 25 - Nylon	SC 116.301
	SCORREVOLE cpl. KN2 - L = 210 + 50 - Nylon	SC 116.302

I codici originali e le applicazioni sono riportati solo a titolo indicativo per favorire l'individuazione dei nostri prodotti

The original codes and applications are given only as a guideline to facilitate the identification of our products

COMPONENTI PER TRASMISSIONI SPARE PARTS

SIMILE A SERIE	DESCRIZIONE	RIF. ARIG
SPICER 1800	Scorrevole cpl. - corsa + 120 - tubo 110 x 6	SC 180.001
	Giunto Scorrevole cpl. - Flangia SAE 1800 - tubo 110 x 6	SC 180.002
	Giunto fisso cpl. - Flangia SAE 1800 - tubo 110 x 6	GF 180.012
	Gruppo Supporto cpl. - Flangia SAE 1800 - tubo 120 x 4	GS 180.001
AC 122 (587 15)	Crocera cpl. - 42 x 104,5	B 122
	Scorrevole +110 mm per tubo 80 x 3,5	SC 587.115
	Forcella fissa per tubo 80 x 3,5 H= 84	FT 587.151
	Flange SAE 1510	FL 587.153
	Flange DIN 120 / 8 fori diam. 10 H=75	FL 587.154
	Flange DIN 150 / 8 fori diam. 12 H=62	FL 587.155
	Flange dentate XS 120 H=75	FL 587.156
AC 133 (587 30)	Crocera cpl. - 52 x 133	B 133
	Scorrevole cpl. - corsa + 110 - tubo 92 x 6,5 - L = 328	SC 587.300
	Forcella fissa - tubo 92 x 6,5 - L = 100	FT 587.311
	Flangia SAE 175 - H = 90	FL 587.321
	Flangia DIN 180 - 8 x 14 - H = 90	FL 587.331
	Flangia DIN 180 - 10 x 16 - H = 90	FL 587.332
	Flangia Dentata 150 - H = 90	FL 587.333
Flangia DIN 150 8 x 12 - H = 90	FL 587.335	
AC 144 (587 35)	Crocera cpl. - 57 x 144	B 144
	Scorrevole cpl. - corsa + 110 - tubo 110 x 6 - L = 338	SC 587.350
	Forcella fissa - tubo 110 x 6 - L = 103	FT 587.352
	Flangia Dentata 180 - H = 100	FL 587.353
	Flangia DIN 180 - 8 x 14 - H = 100	FL 587.354
	Flangia DIN 180 - 10 x 16 - H = 100	FL 587.355
	Gruppo supporto cpl. Diam. 60 - XS 180	GS 587.400
	Tubo 110 x 6 - Interasse 219,5	
AC 126 (385 Mercedes)	Crocera cpl. - 48 x 126	B 126
	Scorrevole cpl. - corsa + 110 - tubo 92 x 5 - L = 327	SC 385.300
	Forcella fissa - tubo 92 x 5 - L = 101	FT 385.011
	Flangia DIN 150 8 x 12 - H = 82	FL.385.201
	Flangia Dentata 150 - H = 75	FL 385.202
AC 135 (389 Mercedes)	Crocera cpl. - 53 x 135	B 135
	Scorrevole cpl. - corsa + 160 - tubo 100 x 5 - L = 373	SC 389.300
	Forcella fissa - tubo 100 x 5 - L = 116	FT 389.011
	Flangia DIN 150 8 x 16 - H = 90	FL 389.201
	Flangia DIN 180 - 8 x 14 - H = 90	FL 389.211
	Flangia DIN 180 - 10 x 16 - H = 90	FL 389.212
	Flangia Dentata 150 - H = 85	FL 389.213
	Flangia XS 165	FL.389.214
	Flangia DIN 165	FL.389.215

I codici originali e le applicazioni sono riportati solo a titolo indicativo per favorire l'individuazione dei nostri prodotti

The original codes and applications are given only as a guideline to facilitate the identification of our products

COMPONENTI PER TRASMISSIONI SPARE PARTS

SIMILE A SERIE	DESCRIZIONE	RIF. ARIG
AC 30 (687 20)	Crocera cpl. - 30,2 x 81,8	B 30
	Scorrevole cpl. - corsa + 70 - tubo 76,2 x 2,4 - L = 191	SC 687.230
	Scorrevole cpl. Corsa + 70 tubo 61 x 3 RILSAN MARRONE	SC 687.231
	Forcella fissa - tubo 76,2 x 2,4 - L = 53	FT 687.211
	Forcella fissa - tubo 61 x 3	FT 687.212
	Flangia SAE 69 - 4 x 11,2 - H = 48	FL 687.221
	Flangia DIN 100 6 x 8 - H = 58 con scarico centrale	FL 687.222
	Flangia DIN 120 - 8 x 10 - H = 54	FL 687.223
	Gruppo supp.cpl. Diam.40 SAE 69 int. 168,4 TUBO 76	GS.687.201
AC 36 (687 30)	Crocera cpl. - 35 x 106,3	B 36
	Scorrevole cpl. - corsa + 110 - tubo 89 x 2,4 - L =245	SC 687.330
	Forcella fissa - tubo 89 x 2,4 - L = 65	FT 687.311
	Flange SAE 95 - 4 x 14,2 - H = 50,8	FL 687.321
	Flangia Dentata 120 - H = 63,5	FL 687.322
	Flangia DIN 120 - 8 x 10 - H = 65	FL 687.323
		Gruppo Supporto cpl. - diam.45 - Flangia XS 120 - L =121 (interasse = 193,8)
AC 35 (687 30)	Crocera cpl. - 34,9 x 106,4	B 35
	Scorrevole cpl. - corsa + 110 - tubo 89 x 2,4 - L =245	SC 687.340
	Forcella fissa - tubo 89 x 2,4 - L = 65	FT 687.341
	Flange SAE 95 - 4 x 14,2 - H = 50,8	FL 687.350
	Flangia Dentata 120 - H = 63,5	FL 687.351
	Flangia DIN 120 - 8 x 10 - H = 65	FL 687.352
		Flangia xs 150
AC 48 (687 40)	Crocera cpl. - 48 x 135,2	B 48
	Scorrevole cpl. - corsa + 110 - tubo 120 x 4 - L = 255	SC 687.430
	Scorrevole cpl. - corsa + 180 - tubo 100 x 4,5 - L = 347	SC 687.435
	Forcella fissa - tubo 120 x 4 - L = 87	FT 687.411
	Forcella fissa - tubo 100 x 4,5 - L = 100	FT 687.412
	Flangia Dentata 150 - H = 82	FL 687.421
	Flangia Dentata 180 - H = 82	FL 687.422
		Gruppo Supporto cpl. - diam.65 - Flangia XS 150 - L =154 (interasse = 230)
AC 47 (687 40)	Crocera cpl. - 47,6 x 135,2	B 47
	Scorrevole cpl. - corsa + 110 - tubo 120 x 3 - L = 255	SC 687.440
	Forcella fissa - tubo 120 x 3 - L = 87	FT 687.441
	Flangia Dentata 150 - H = 82	FL 687.460
	Flangia Dentata 180 - H = 82	FL 687.461

I codici originali e le applicazioni sono riportati solo a titolo indicativo per favorire l'individuazione dei nostri prodotti

The original codes and applications are given only as a guideline to facilitate the identification of our products

COMPONENTI PER TRASMISSIONI SPARE PARTS

SIMILE A SERIE	DESCRIZIONE	RIF. ARIG
AC 52 (687 45)	Crocera cpl. - 52 x 147,2	B 52
	Scorrevole cpl. - corsa + 110 - tubo 120 x 4 - L = 265	SC 687.450
	Forcella fissa - tubo 120 x 4 - L = 95	FT 687.452
	Flangia Dentata 180 - H = 87	FL 687.453
	Gruppo Supporto cpl. - diam.65 - Flangia XS 180 - L=154 Interasse 230	GS 687.455
AC 57 (687 55)	Crocera cpl. - 57 x 152	B 57
	Scorrevole cpl. - corsa + 110 - tubo 120 x 6 - L = 287	SC 687.550
	Scorrevole cpl. - corsa + 110 - tubo 110 x 6 - L = 287	SC 687.558
	Forcella fissa - tubo 120 x 6 - L = 100	FT 687.552
	Forcella fissa - tubo 110 x 6 - L = 105	FT 687.557
	Flangia SAE 1800 - 12 x 10,10 - H = 95	FL 687.553
	Flangia DIN180 - 10 x 16 - H = 95	FL 687.554
	Flangia Dentata 180 - H = 92	FL 687.555
AC 60 (687 60)	Crocera cpl. - 59 x 167	B 59
	Scorrevole cpl. +110 mm tubo 130 x 6	SC 687.660
	Forcella fissa - tubo 130 x 6	FT 687.662
	Flangia SAE 1800 12/10	FL.687.663
AC 65 (687 65)	Crocera cpl. - 65 x 172	B 172
	Scorrevole cpl. +110 mm tubo 142 x 6	SC 687.660
	Forcella fissa - tubo 142 x 6	FT 687.662
	Flangia SAE 1800 12/10	FL.687.663

I codici originali e le applicazioni sono riportati solo a titolo indicativo per favorire l'individuazione dei nostri prodotti

The original codes and applications are given only as a guideline to facilitate the identification of our products

TABELLA FLANGE FLANGES TABLE

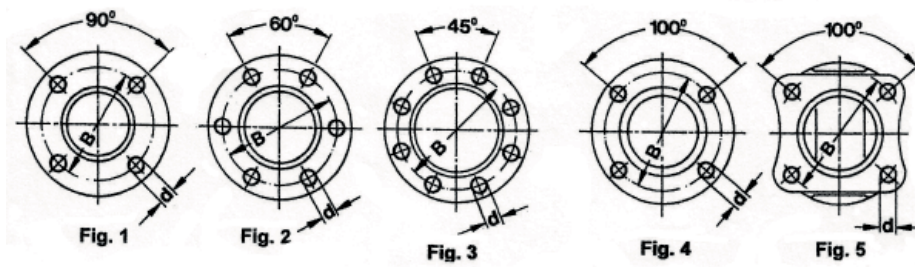

T X Z	SERIE	FIG.	TIPO	A	B	C	NR. FORI	D	P	G	H	β	COD.ARIG
23,8 x 61,3	AC 62	1	SAE	1120	69.85	57.15	4	8.25	1.4	7	33	18°	FL.062.001
		4	DIN	75	62	42	6	6	2	5	42	18°	FL.062.010
		3	DIN	90	74.5	47	4	8.25	2.5	6.5	33	18°	FL.062.011
27 x 74,8	AC 768	1	SAE	1120	69.85	57.15	4	8.25	1.3	9	43	25°	FL.768.001
		1	SAE	97	79.37	60.32	4	10.25	1.3	8	43	25°	FL.768.002
		3	DIN	90	74.5	47	4	8.5	2.7	9	50	25°	FL.768.003
27 x 81,7	AC 82	1	SAE	1120	72.30	57	4	8.25	1.4	8	39.5	22°	FL.082.001
		1	SAE	1310	79.37	60.32	4	10.25	1.4	7	35	18°	FL.082.002
		1	SAE	1310	79.37	60.32	4	10.25	1.4	11	45.5	22°	FL.082.003
		1	SAE	1310	79.37	60.32	4	10.25	1.4	8	58	35°	FL.082.004
		1	SAE	1410	95.30	69.85	4	12.25	1.4	8	50.5	22°	FL.082.005
		3	DIN	90	74.5	47	4	8.5	2.5	7	40	18°	FL.082.005
		4	DIN	100	84	57	6	8.5	2.5	8	60	35°	FL.082.013
		5	DIN	120	101.5	75	8	10.5	2.5	8.5	51	25°	FL.082.016
30,2 x 82	AC767N/WS	1	SAE	1310	79.37	60.32	4	10.25	1.6	8	58	35°	FL.767.001
		1	SAE	120	95.25	69.85	4	12.25	1.3	8	58	35°	FL.767.002
		4	DIN	100	84	57	6	8.5	3.2	8	58	35°	FL.767.003
		5	DIN	120	101.5	75	8	10.5	3	8	58	35°	FL.767.004
30,2 x 92	AC 92	2	SAE	1410	95.27	69.85	4	12.25	1.4	8.5	44	18°	FL.092.002
		4	DIN	100	84	57	6	8.5	2.5	8	58	33°	FL.092.010
		5	DIN	120	101.5	75	8	10.5	2.5	8	59	35°	FL.092.012
30,2 x 106,3	AC 106	2	SAE	1410	95.27	69.85	4	12.25	1.4	7.5	43	18°	FL.106.001
		4	DIN	100	84	57	6	8.5	2.5	8	68	25°	FL.106.010
		5	DIN	120	101.5	75	8	10.5	2.5	8	69	25°	FL.106.014
39,7 x 115,9	AC 116	1	SAE	1510	120,67	95.25	4	14.25	2	12.5	62.5	20°	FL.116.002
		5	DIN	120	101.5	75	8	10.5	3	10	72.5	25°	FL.116.010
		5	DIN	150	130	90	8	12.5	3	11	79	25°	FL.116.012

I codici originali e le applicazioni sono riportati solo a titolo indicativo per favorire l'individuazione dei nostri prodotti

The original codes and applications are given only as a guideline to facilitate the identification of our products

SUPPORTI PER TRASMISSIONI CENTER BEARINGS

FIGURA	DIAM CUSCINETTO X LARGHEZZA	INTERASSE FORI	ALTEZZA	APPLICAZIONE/ Application	RIF.ARIG
	30 x 13	140	/	Ford Transit - 88VB 4826 AA	S 30.001
	30 x 13	144	64	Ford Transit - O.E.N° 95VB4826AA - 7239265 - 99VB4826 AB - 4060617 / YCIW4826 BC -4104708	S 30.002
	30 x 13			Land rover - Free Lander - Oem : TOQ000040	S 30.003
	30 x 13			Ford transit centra- to - 92 VB 4826 CA - 6635542	S.30.004
	30 x 19			VW Touareg - Por- sche Cayenne Oem: 100008900022	S30.005
	30 x 15			Fiat panda 4 x 4 new model Oem.:808682	S 30.006

I codici originali e le applicazioni sono riportati solo a titolo indicativo per favorire l'individuazione dei nostri prodotti

The original codes and applications are given only as a guideline to facilitate the identification of our products

SUPPORTI PER TRASMISSIONI CENTER BEARINGS

FIGURA	DIAM CUSCINETTO X LARGHEZZA	INTERASSE FORI	ALTEZZA	APPLICAZIONE/ Application	RIF.ARIG
	25 x 18			Fiat panda 4 x 4 old model Oem. 7541164	S 30.007
	30 x 13			Ford sierra & Scorpio - 83BG 4826 BA-1613023 / 95GG4826 AB - 1016190	S 30.008
	30 x 13			Volkswagen LT - 293521351	S 30.009
	30 x 13			APPLICATION: GM / Opel / Vauxhall / Omega A / Senator B - 90343676 - 0458009	S30.010
	30 x 13			GM / Opel / Vauxhall Omega B / Vauxhall Omega 90470670 - 0458014	S30.011
	30 x 16			Hyundai starex 491304A000	S30.012

I codici originali e le applicazioni sono riportati solo a titolo indicativo per favorire l'individuazione dei nostri prodotti

The original codes and applications are given only as a guideline to facilitate the identification of our products

SUPPORTI PER TRASMISSIONI CENTER BEARINGS

FIGURA	DIAM CUSCINETTO X LARGHEZZA	INTERASSE FORI	ALTEZZA	APPLICAZIONE/ Application	RIF.ARIG
	30 x 16			Mitsubishi L200 pick up MB154706	S30.013
	30 x 13			mercedes vito poste- riore - 6394100681	S30.014
	30 x 16			nissan d22 pick up - 37522 -w1625	S30.015
	25 X 15			Mazda B2200 - P047- 025-310A	S30.016
	30 x 15			Renault Scenic & Kan- goo 4x4	S30.017
				jaguar	S30.018

I codici originali e le applicazioni sono riportati solo a titolo indicativo per favorire l'individuazione dei nostri prodotti

The original codes and applications are given only as a guideline to facilitate the identification of our products



SUPPORTI PER TRASMISSIONI CENTER BEARINGS

FIGURA	DIAM CUSCINETTO X LARGHEZZA	INTERASSE FORI	ALTEZZA	APPLICAZIONE/ Application	RIF.ARIG
	30 x 13			Mercedes vito anteriore - 6394100481	S30.019
	35 x 17	168	60	Fiat OM IVECO Daily -OM Grinta 9932698 OEM.9984261	S 35.001
	35 x 17	160	/	Mercedes - 609 - O.E.N° 4604100910 - 4604100222 - 4604100022	S 35.002
	35 x 17	157	/	Mercedes: 309 - 408 - 508 - 603 - 613 O.E.N° 3104100822	S 35.003
	35 x 14			New ford transit 200 - decenter / 8c11 4826 AA 1510905	S 35.004
	40 x 18	168.4	65	Eurocargo:60E.10/12- 14 65E.12/14 - 75E.14 O.E.N° 42536965 - 93160223	S 40.001/5

I codici originali e le applicazioni sono riportati solo a titolo indicativo per favorire l'individuazione dei nostri prodotti

The original codes and applications are given only as a guideline to facilitate the identification of our products

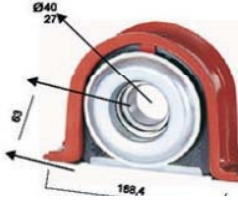
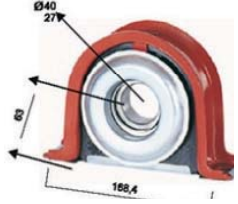
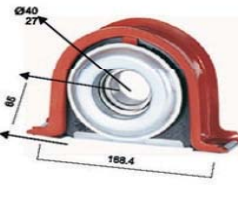
SUPPORTI PER TRASMISSIONI CENTER BEARINGS

FIGURA	DIAM CUSCINETTO X LARGHEZZA	INTERASSE FORI	ALTEZZA	APPLICAZIONE/ Application	RIF.ARIG
	40 x 27	168.4	63	Isuzu / Magirus/ Mitsubishi/Daewoo / Hyunday	S 40.002
	40 x 27	168.4	63	Mitsubishi canter	S 40.003
	40 x 27	168.4	65	Iveco -Fiat 50NC - 100EC - 645 - 650N/ N1-2-	S 40.004
	40 X 18			Mitsubishi canter FE.659/EF BM563204	S 40.006
	40 x 21			Iveco turbo daily OE 42530546	S 40.007

I codici originali e le applicazioni sono riportati solo a titolo indicativo per favorire l'individuazione dei nostri prodotti

The original codes and applications are given only as a guideline to facilitate the identification of our products







SUPPORTI PER TRASMISSIONI CENTER BEARINGS

FIGURA	DIAM CUSCINETTO X LARGHEZZA	INTERASSE FORI	ALTEZZA	APPLICAZIONE/ Application	RIF.ARIG
	45 x 19	168	59.5	IVECO-New Daily- turbo daily -daily- bus new daily O.E.N° 93156460	S 45.001/3
	45 x 19	193.6	69	Iveco:79.13 - 95.14 - 115.17 - O.E.N° 4614631 - 4639052 - 4642213	S 45.002
	45 x 16	144	62	Ford Transit turbo- O.E.N° 98-VD-4826- AAK-6649122	S 45.004
	45 x 19	194	71	Mercedes: 207-208- 209-210-307-308-309- 310-407-408-409-410 O.E.N° 6014101710	S 45.005
	45 x 16			Volvo - Opel Frontera Oem: 1340501	S45.006
	45 x 19	195	71.5	Mercedes Sprinter / Vw Volt - O.E.N° 9014110310 O.E.N° 9014110312 9034100010	S 45.007/10

I codici originali e le applicazioni sono riportati solo a titolo indicativo per favorire l'individuazione dei nostri prodotti

The original codes and applications are given only as a guideline to facilitate the identification of our products





SUPPORTI PER TRASMISSIONI CENTER BEARINGS

FIGURA	DIAM CUSCINETTO X LARGHEZZA	INTERASSE FORI	ALTEZZA	APPLICAZIONE/ Application	RIF.ARIG
	45 x 25	191	/	Mercedes - 814 - 817 - 914 - 917 - 1117 - 1317 - 1517 O.E.N° 3814100222 - 3954100222	S 45.008
	45 x 19			Mercedes atego Oem: 6704110112 - 9704110112- 9704110012	S45.009
	45 X 19			Iveco - Fiat - Ford Chrysler - BMC - JCB - Renault 6381862- 42536523 - 4614631 - 4639052 - 4622213 - 5000821936 - 5000242914	S45.011
	45 x 19			Kit mercedes sprinter- Vw Volt / OE: 9014110312- 9014110412- 2D0521351	S45.012
	47 x 21			Kit mercedes sprin- ter H=68- OE: 9064100181	S45.013
	47 x 21			Kit mercedes sprin- ter H=73 - OE: 9064100281	S45.014

I codici originali e le applicazioni sono riportati solo a titolo indicativo per favorire l'individuazione dei nostri prodotti

The original codes and applications are given only as a guideline to facilitate the identification of our products

SUPPORTI PER TRASMISSIONI CENTER BEARINGS

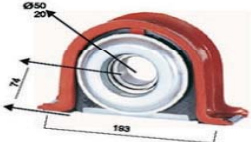
FIGURA	DIAM CUSCINETTO X LARGHEZZA	INTERASSE FORI	ALTEZZA	APPLICAZIONE/ Application	RIF.ARIG
	45 x 16			IVECO Daily I-II .E.N° 93156460	S45.015
	45 x 27			Iveco/Bmc / Chreysler /JCB / Bedford OE : 1667743 - 93158251	S45.016
	45 x 23			Mercedes OE: 3 8 1 4 1 0 0 0 1 0 - 3 8 1 4 1 0 1 5 2 2 - 3814100920	S45.017
	47 x 21		73	Mercedes sprinter / Vw Crafter 2006 - O.E.N° 9064100281	S45.018
	45 x 19			Nissan Navara Pick up	S45.019
	50 x 20	193	74	FIAT 643 EP OE 4503320	S50.001

I codici originali e le applicazioni sono riportati solo a titolo indicativo per favorire l'individuazione dei nostri prodotti

The original codes and applications are given only as a guideline to facilitate the identification of our products

SUPPORTI PER TRASMISSIONI CENTER BEARINGS

FIGURA	DIAM CUSCINETTO X LARGHEZZA	INTERASSE FORI	ALTEZZA	APPLICAZIONE/ Application	RIF.ARIG
	50 x 20			FIAT / DAF / RENAULT Oe: 5765838 - 4503320-5000589888- 4765836	S50.002
	55 x 18	195	76	Iveco:A175.24 - 230PM26 Eurocargo:150E.23/27 - Eurotech:180E.24/27 O.E.N° 8194600 - 42536524	S 55.001
	55 x 25	191	/	Mercedes truck: O.E.N° 3854100922	S 55.002
	55 x 21			Mercedes Oem: 3854101722 -3854101622 - - 9734100022	S 55.003
	55 x 21	220		Mercedes Man Oem. 3184101522	S 55.004
	55 x 21			Mercedes Actros 9734100112- 9734100012	S 55.005

I codici originali e le applicazioni sono riportati solo a titolo indicativo per favorire l'individuazione dei nostri prodotti

The original codes and applications are given only as a guideline to facilitate the identification of our products

SUPPORTI PER TRASMISSIONI CENTER BEARINGS

FIGURA	DIAM CUSCINETTO X LARGHEZZA	INTERASSE FORI	ALTEZZA	APPLICAZIONE/ Application	RIF.ARIG
	60 x 36	200	82	Iveco:190.26 -190.30/35/38 -170.26 170.33 OE 4803933 - 93191989 - (42002125) 4473133	S 60.001
	60 x 22	220	86	BMC / DAF / IVECO / Mercedes / Ford O.E. N° 93157125- 93157126-4k11254	S 60.002
	60 x 20	220	88	Iveco turbo tech / trubo star / 190.36 - 240.36 /26- 230.36 190.36/42 260.36 O.E. 93157125	G60.002 in ghisa
	60 x 38	220	88	Iveco turbostar / turbo tech / eurotech 190.42 / 240.36 /260.36 /240.26 /190.36 / 230.36 180. e34/e42 190.e240.E. N°9315 7626	G 60..003 in ghisa
	60 x 22	247.6	/	Mercedes truck : 2028 - 2628 - 3328 - 3536 2626 2633 2636 3338 O.E.N° 6544100022 - 3894100222 3894100122	S 60.003
	60 x 30	/	/	Volvo - O.E.N° 1696389	S 60.004

I codici originali e le applicazioni sono riportati solo a titolo indicativo per favorire l'individuazione dei nostri prodotti

The original codes and applications are given only as a guideline to facilitate the identification of our products

SUPPORTI PER TRASMISSIONI CENTER BEARINGS

FIGURA	DIAM CUSCINETTO X LARGHEZZA	INTERASSE FORI	ALTEZZA	APPLICAZIONE/ Application	RIF.ARIG
	60 x 36	220	87	Iveco O.E.N° 93157626	S 60.005
	60 x 22	/	/	Scania 112 P.90 P.400 - P.500 - P.6000 O.E.N° 294270	S 60.006
		199	/	Volvo - struttura ester- na - O.E.N° 263006	S 60.701
	65 x 23	230	85	Man Truck / bmc / iveco / 26.270 - O.E.N° 81394106017 - N° 81394106013	S 65.001
	70 x 43	220	88	Iveco - Turbostar - trurbo teck - euro- trakker - eurostar : 190.38 - 190.36/36P - 190.42/42P - 190.48- 190.e42 /47 240.E42/ e47 240.36- 240.48 260.E47/52 - O.E.N° 42087410	K 70.001 in ghisa
	70 x 20	220	86	Iveco turbostar 190.30T / 190.33T /190.36T /190.38 /190.42 /190.48. N°42087542	S 70.002

I codici originali e le applicazioni sono riportati solo a titolo indicativo per favorire l'individuazione dei nostri prodotti

The original codes and applications are given only as a guideline to facilitate the identification of our products

SUPPORTI PER TRASMISSIONI CENTER BEARINGS

FIGURA	DIAM CUSCINETTO X LARGHEZZA	INTERASSE FORI	ALTEZZA	APPLICAZIONE/ Application	RIF.ARIG
	70 x 20	220	88	Iveco Eurotech /Eurostar/eurotrakker 180E34 /E42/ 190. E26 /E34/E38/E42 oe. 93190884	G70.002 in ghisa
	70 x 22	220	86	Iveco -Eurotech: 180E34 - 190E34 - 240E38 - 260E38 - 340E34/42 - 360E38/42 - 400E34/52 - 440E O.E.N° 93163689 - 93190884	S 70.003
	70 x 20	246	/	Mercedes truck actros- O.E.N° 3954100622 O.E.N° 655410022	S 70.004
	70 x 20	/	/	Volvo - O.E.N° 263567 - 16229 553817 1366	S 70.005
	75 x 20	230		Man tge Oem: 81394106020	S 75.001
	75 x 20	220	83	Man tge Oem: 81394106107	S75.002
	85 x 13	220	85	Man Tge Oem: 81394106031	S85.001